

QUADRALIZER AMPLIFIER

QL-6000A

FVW KLW

Input and output ass'y AWM-026

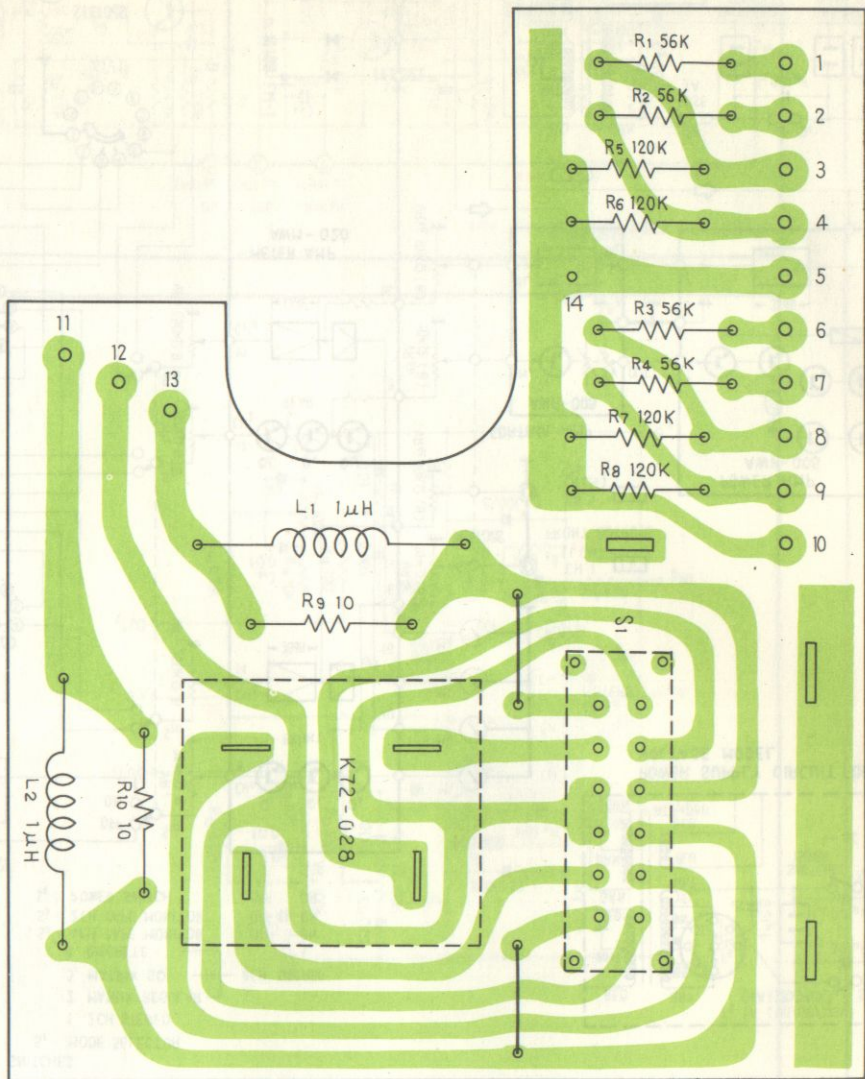

Power supply ass'y AWR-016

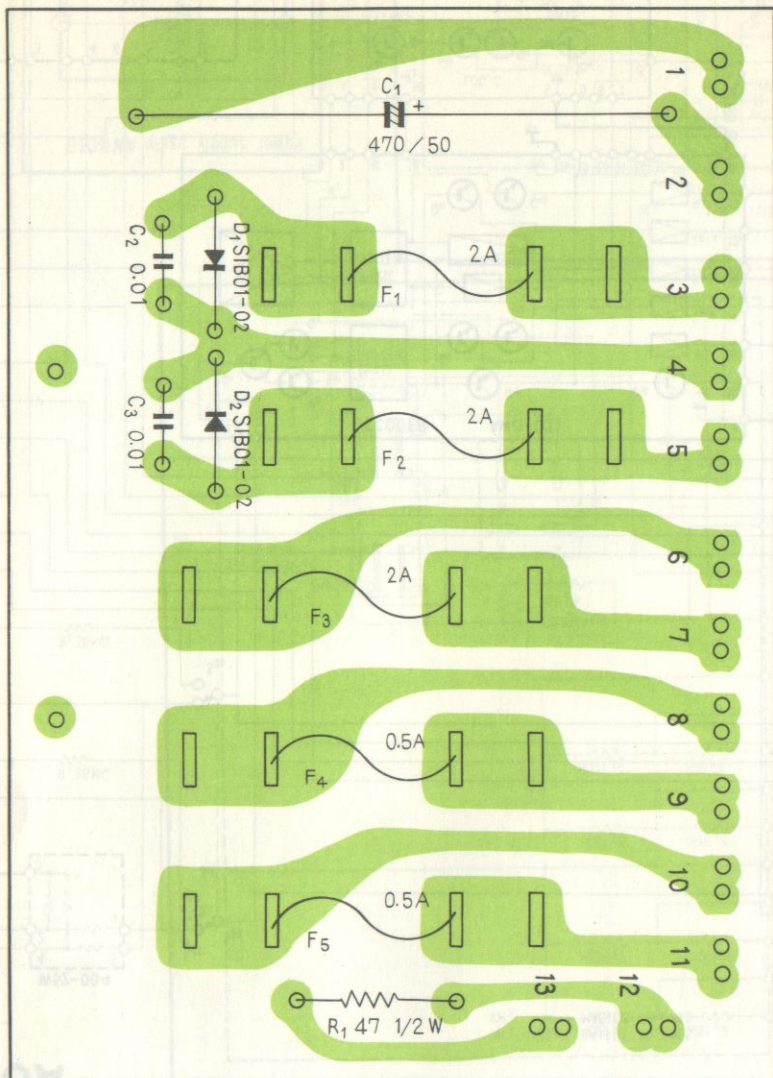

Control amp ass'y AWG-009

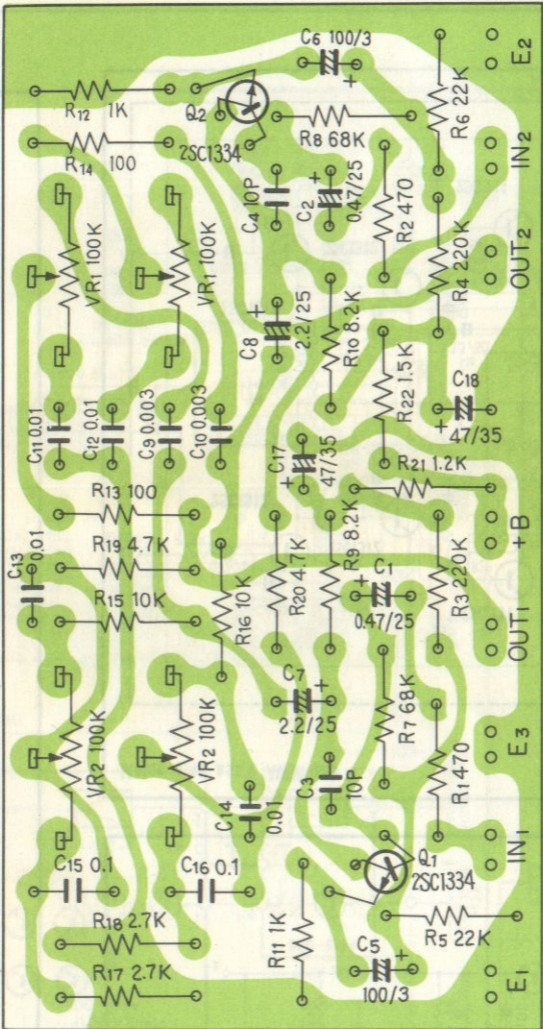

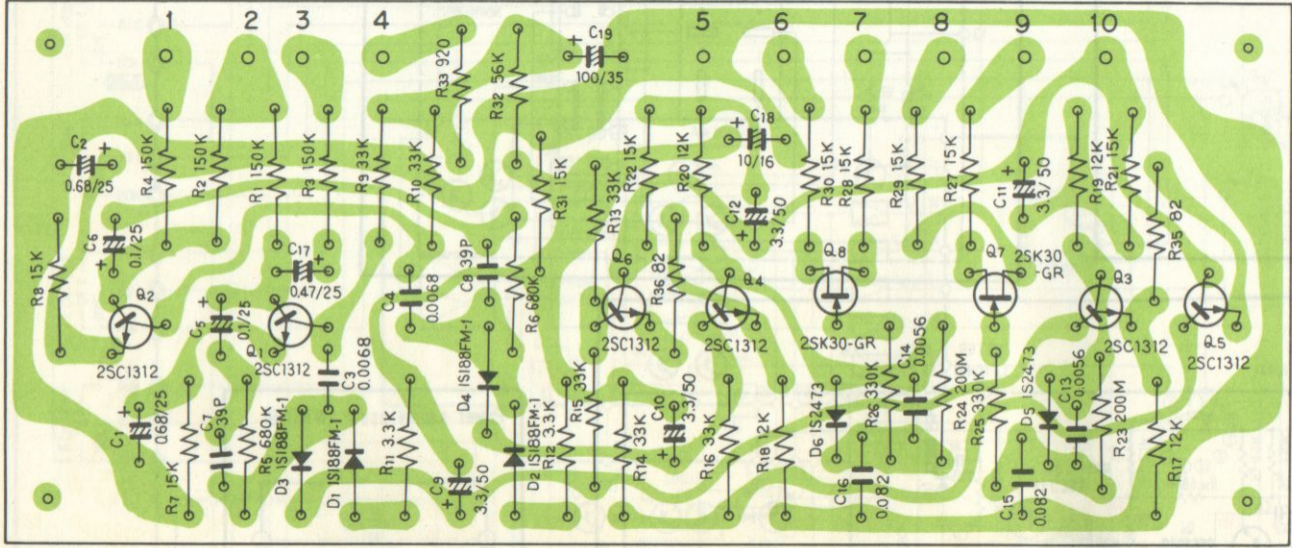

Power amp ass'y AWH-005

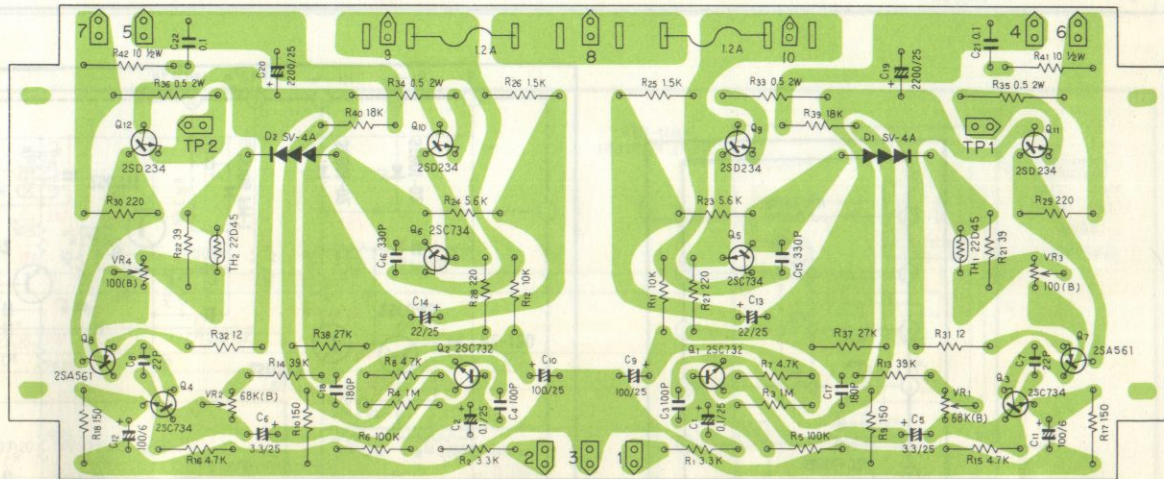

Decoder ass'y AWM-031

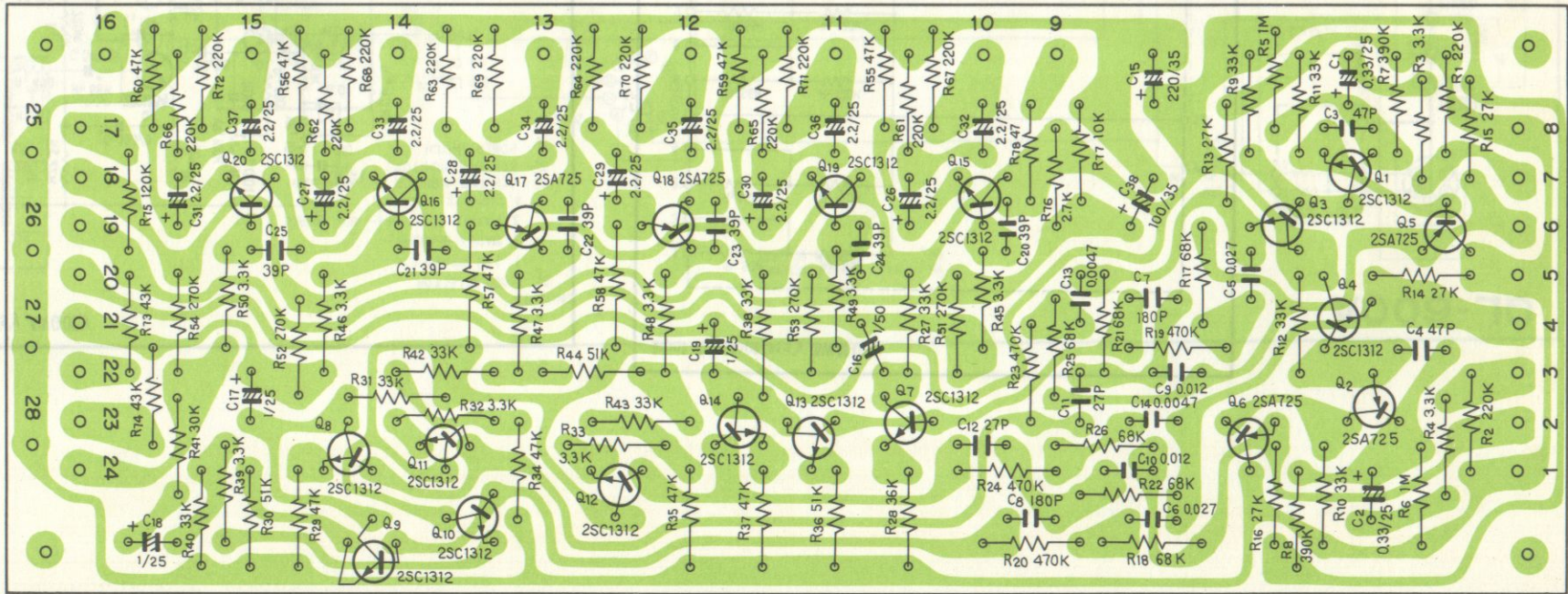

QL-600A

VR₁ ~ VR₄ : PRISSET VOLUMES
VR₅ : MASTER VOLUMES

SWITCHES

- S₁ : MODE SELECTOR
 1. 2CH STEREO
 2. MATRIX REGULAR
 3. MATRIX SQ
 4. DISCRETE
- S₂ : 4CH TAPE MONITOR OFF ON
 S₃ : 2CH TAPE MONITOR OFF ON
 S₄ : POWER SWITCH OFF ON

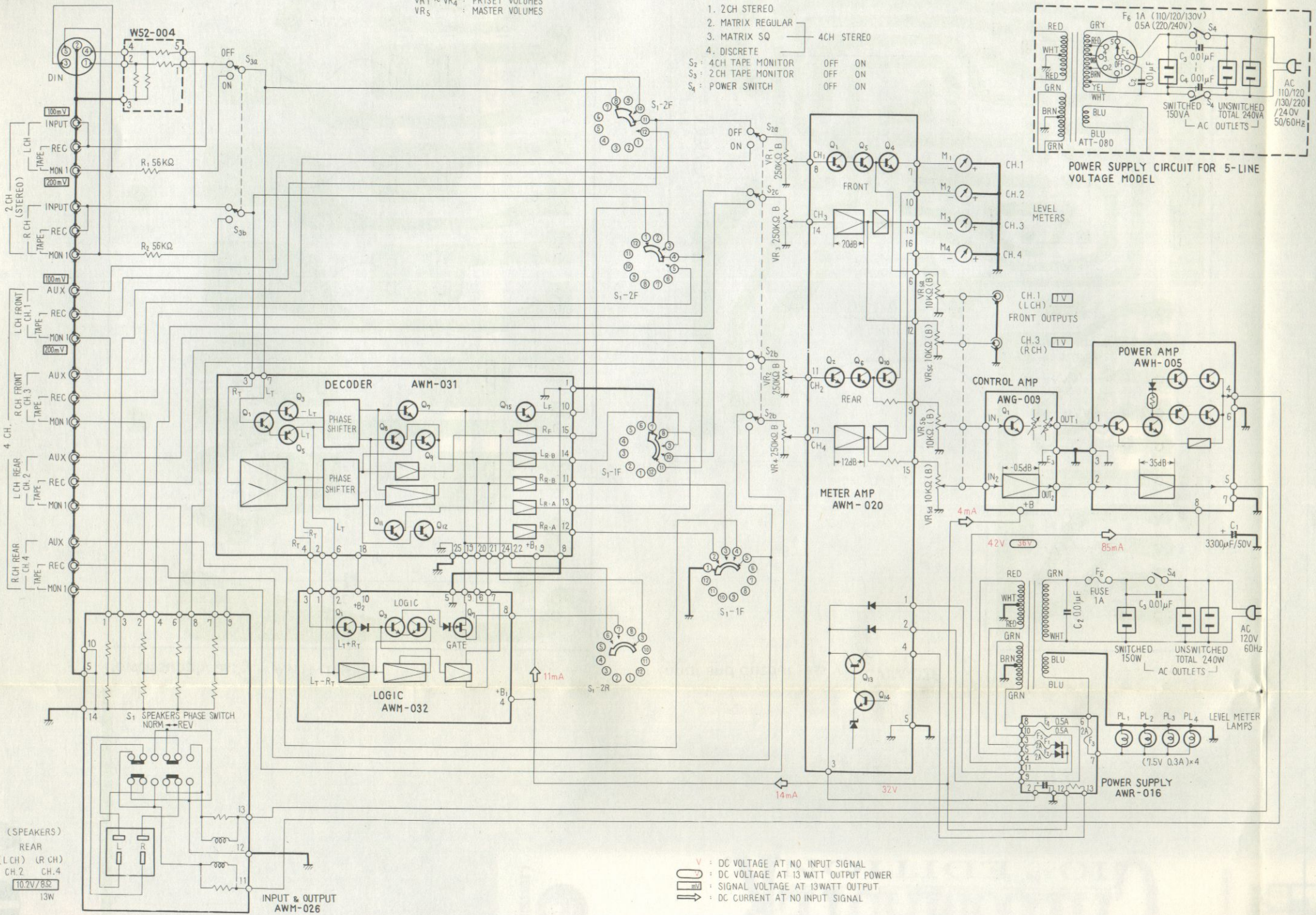

V : DC VOLTAGE AT NO INPUT SIGNAL
 V : DC VOLTAGE AT 13 WATT OUTPUT POWER
 V : SIGNAL VOLTAGE AT 13 WATT OUTPUT
 I : DC CURRENT AT NO INPUT SIGNAL

Input & output ass'y AWM-026

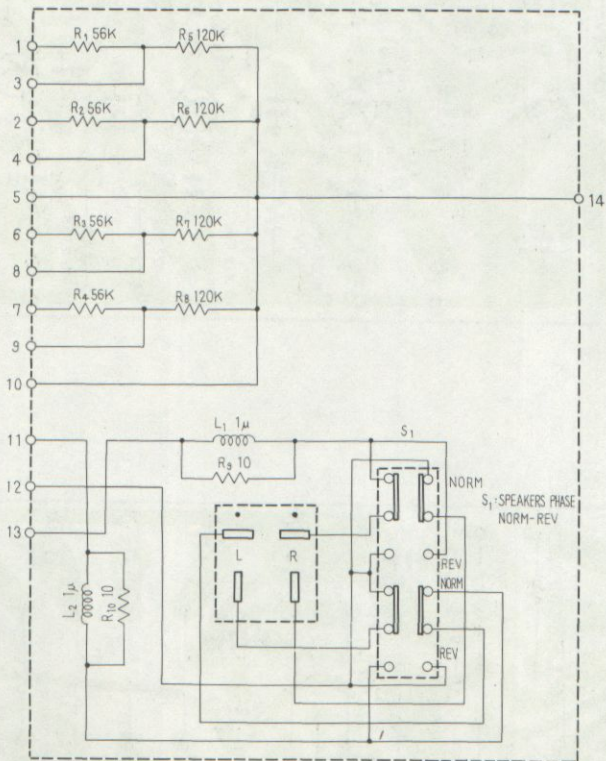

Meter amp ass'y AWM-020

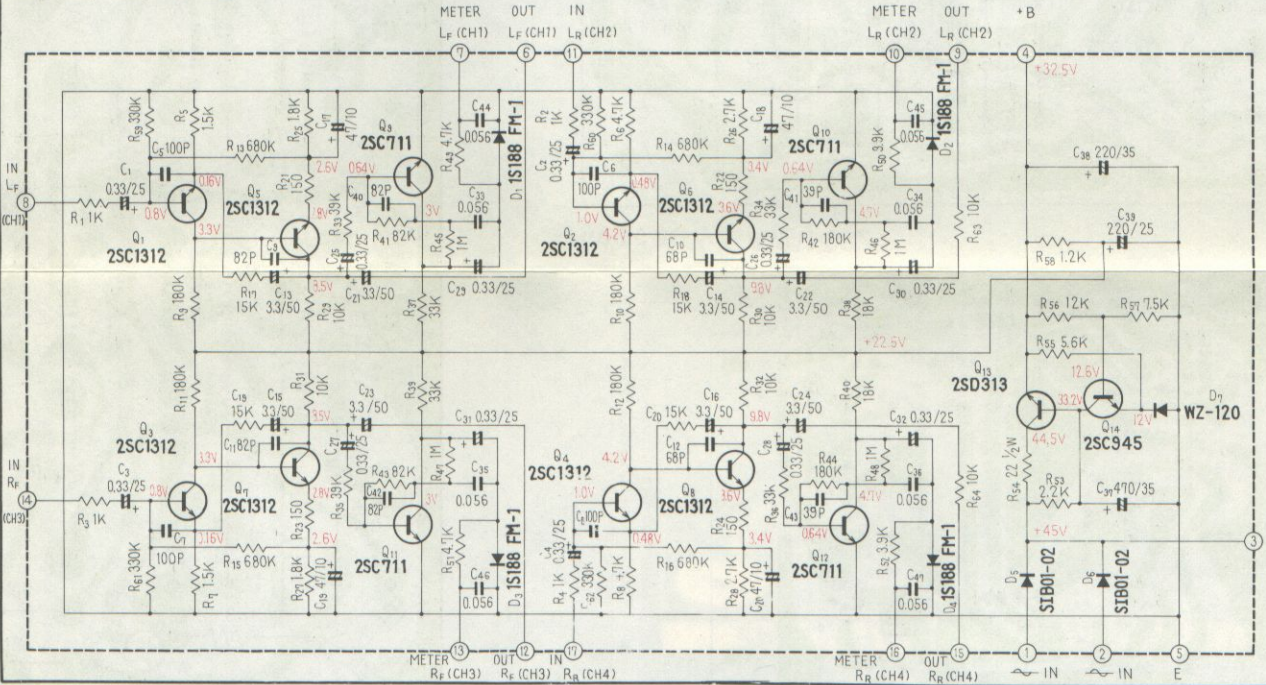

Control amp ass'y AWG-009

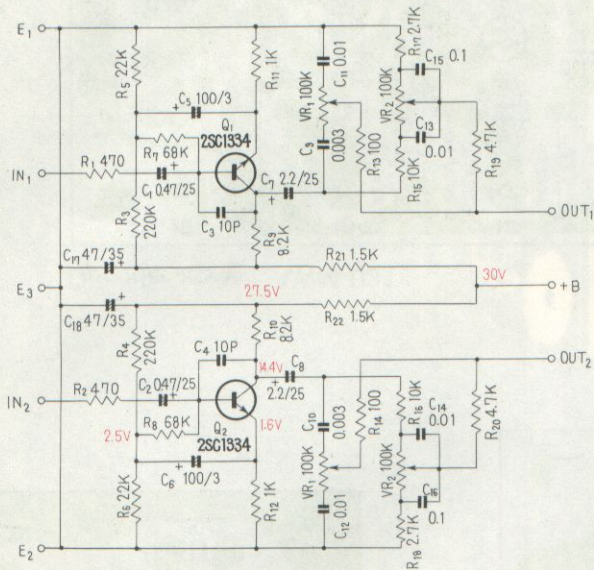

Input & output ass'y AWM-026

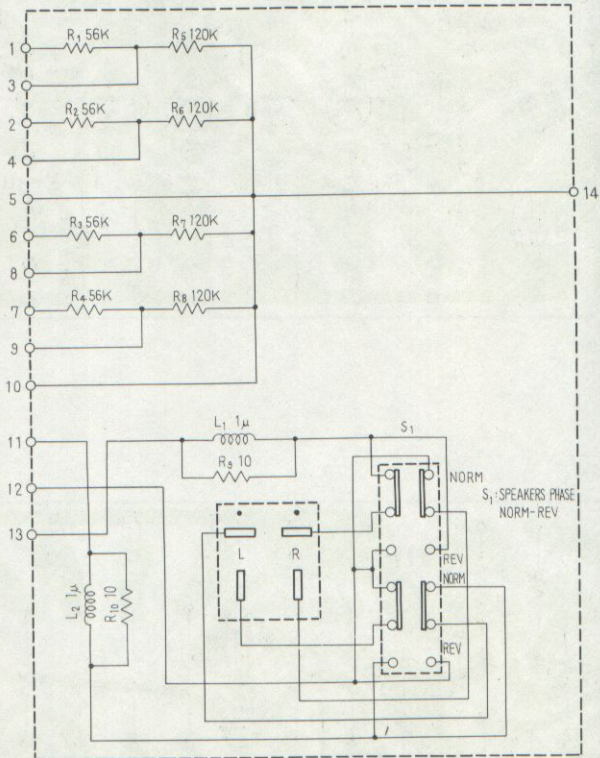

Power amp ass'y AWH-005

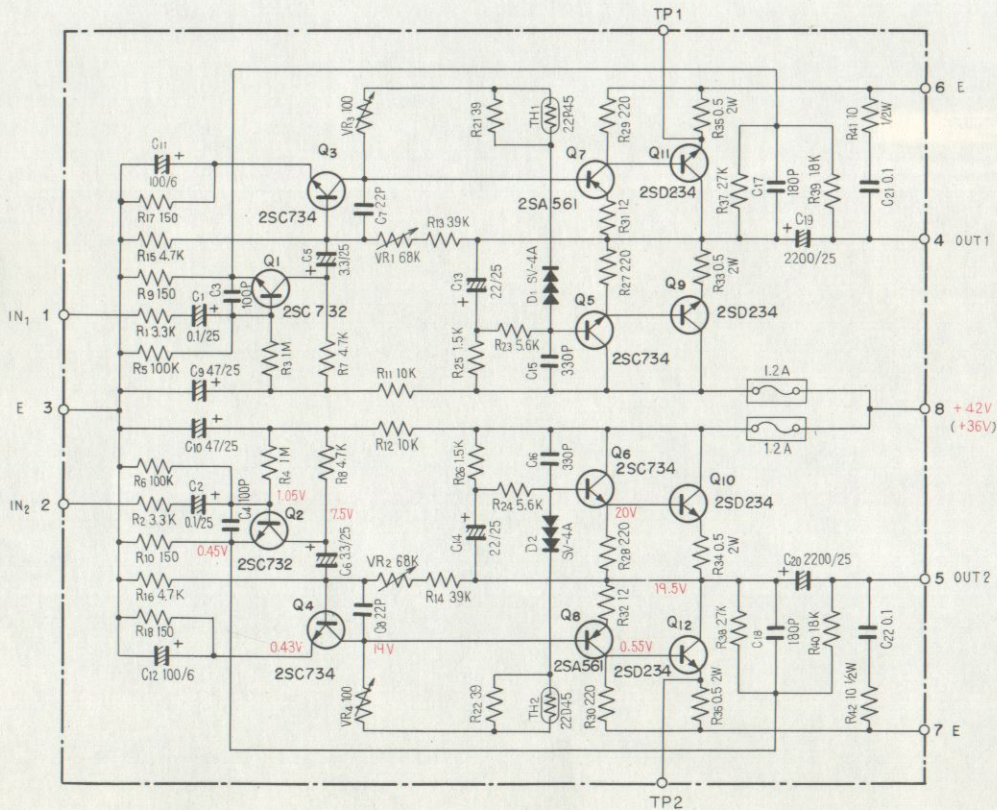

Meter amp ass'y AWM-020

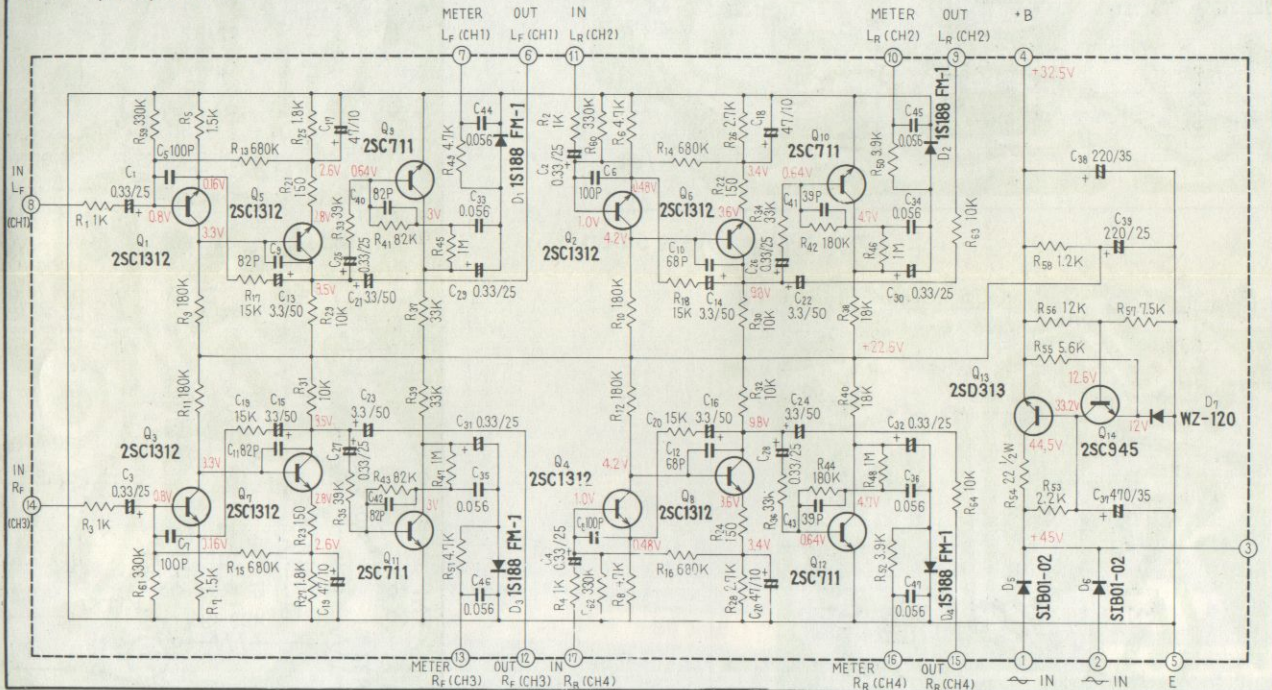

Power supply ass'y AWR-016

